

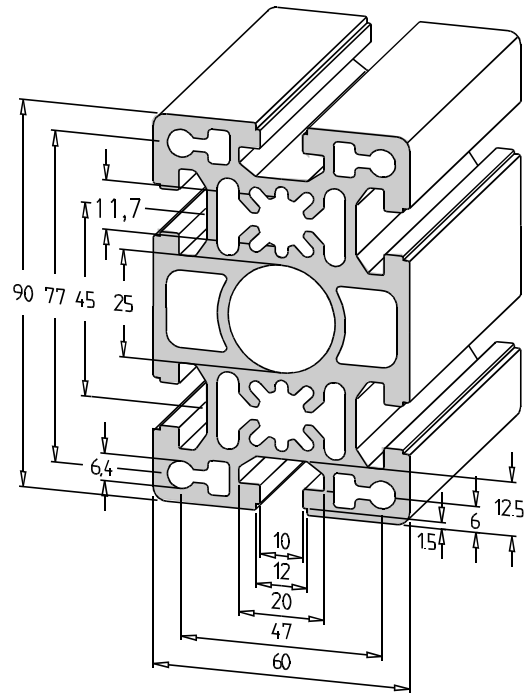

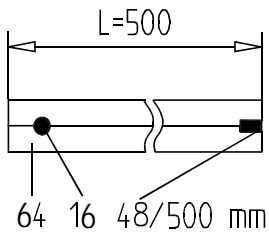







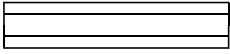

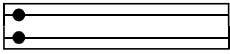

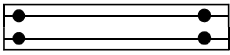

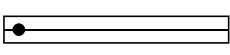

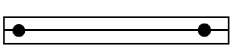

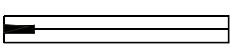

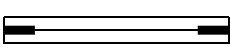

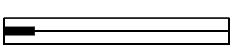
60 x 90

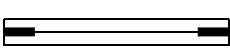

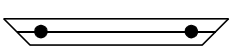
	5 x 6000 mm		64 00 00/..... mm
	1 x 6000 mm		64 00 01/..... mm
			64 02 02/..... mm
			64 16 02/..... mm
			64 16 16/..... mm
			64 15 02/..... mm
			64 15 15/..... mm
	M8x20 (2x)		64 42 02/..... mm
	M8x20 (2x)	 M8x20 (2x)	64 42 42/..... mm
	M14x100 (2x)		64 48 02/..... mm
	M14x100 (2x)	 M14x100 (2x)	64 48 48/..... mm
	45°	 45°	64 35 35/..... mm
	45°	 45°	64 36 36/..... mm

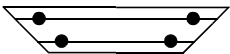
Nach Bearbeitungsliste Seite 3.0.5–3.0.6 bzw. nach Ihrer Skizze

Compare outline of end finishing page 3.0.5–3.0.6, res. according to your own sketch

64 99 99/..... mm

Selon sommaire de usinage des extrémités page 3.0.5–3.0.6, ou bien votre propre dessin

Conforme a la tabella de la lavorazione delle estremità pagina 3.0.5–3.0.6, rispet. schizzo costruttivo

Ver lista de mecanizar los extremos pag. 3.0.5–3.0.6, o bien segun un esbozo de Ud.